



*Platform system
Nivoflex[®] professional
World master when it's
a question of stability.
Original picture.*

*Wir machen Theater!
Weltweit. Seit 1877*



**Bühnenbau
Schnakenberg
Wuppertal
Berlin**

Mobile platform systems
More success through
multi-functionality

Successful past. Brilliant future.

Bühnenbau Schnakenberg was founded in 1877 and, from the smallest beginnings, has developed into a milestone-setting enterprise in the area of performance technology and with innovative ideas given a significant impulse to further technical development.

Up to today the company policy, first written down in 1891 for the operation of the company and its employees, has remained the same:

“We will never put our name on a product to which we haven’t given the best that we possibly can.”

Today Bühnenbau Schnakenberg is world-wide leader in various production areas and has moreover at its disposal the strongest marketing partners of this industry.

Modern production facilities and manufacturing methods, friendly, motivated and dedicated employees and a unique Know-How offer the guarantee for a successful mastery of the present and future tasks.

Index

	page
NIVOflex® – Professional	6
NIVOflex® – Professional Giant	7
NIVOflex® – Professional Elephant	7
NIVOflex® – Professional AirStage	8
NIVOflex® – Stabilo	9
NIVOflex® – Light	10
NIVOflex® – Event scissors	11
NIVOflex® – Event	12
NIVOflex® – Multi	14
NIVOflex® – Special platform	15
NIVOflex® – System accessories	16
NIVOflex® – Technical data	19

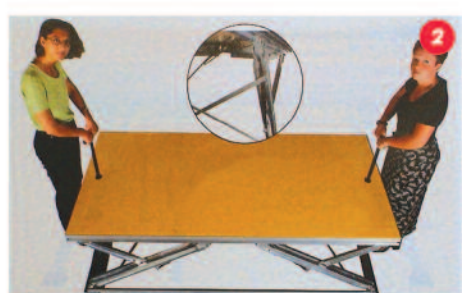
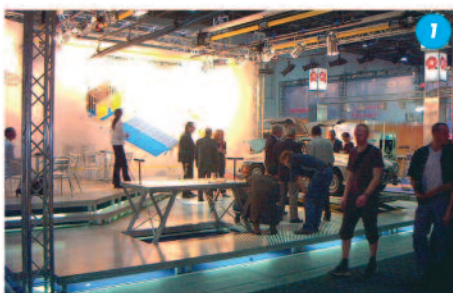
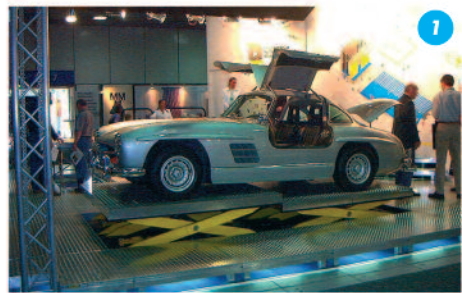



Mobile platforms are by no means an invention of Bühnenbau Schnakenberg although in 1970 we developed the worldwide first fully aluminium platform. Already in antiquity wooden platforms were used in the theatre for scenic portrayals.

Today modern Nivoflex®-Platforms are a stable and universal platform for performances and applications which have largely grown up over the ever-dominating presentation sector of the classic areas of culture, entertainment and sport.

Spectator events under further education, information, representation and, ultimately, from the sales point of view, have become an indispensable part of business life.

Speakers and actors must be seen. Participants and customers wish to and must see.

Nivoflex®-Platform Systems are indispensable today in banks, insurance, industry and commerce for temporary use in foyers, entrance halls, passages, seminar and sales rooms. For the cost effective and rapid transformation of rooms with flat floors into classic presentation areas with podium or stage and rising rows of chairs in the most divergent varieties of construction. Each with its atmosphere appropriate to the presentation and ideal lines of view for actors and participants.

Our product philosophy is called multi-functionality. And has been since 1877

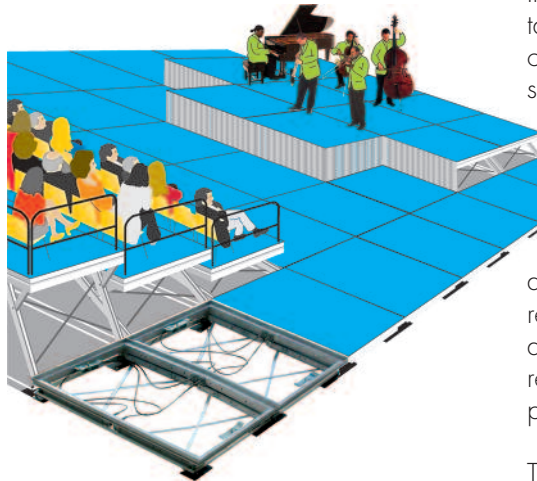

For the fairly rapid change of presentation and/or with no existing possibilities for mobile platforms we recommend our virtually invisible platform system which is integrated into the floor and which changes every flat floor into an appropriate stage and floor configuration motorized with the push of a button or manually with servo-support.

If interested in such projects, please ask for our pdf presentation of references NIVOflex®-Airstage all over the world.

With production runs, industry must deal with the different body size of workers and different heights for the various operations. Platforms can be set to any required height in comparatively minimal time and thereby at any time changed to suit operational requirements.

In business, the optimal product presentation with an offer that can hardly be overlooked is of constantly increasing significance. NIVOflex-Platforms are from design, manufacture and the possibilities of individual fabrication with regard to the dimensions, surfaces and colours, the ideal basis for a presentation which gives every product its significance with regard to its relatively elevated position. Significant appearances by personalities and actors require a stage. The same goes for premium products.

The possible applications of platform systems in a constantly changing world with a high demand for multi-functionality of buildings, facilities and furnishings are practically unlimited.

With NIVOflex® platforms you are deciding for the security of a world-wide and million times proven system.



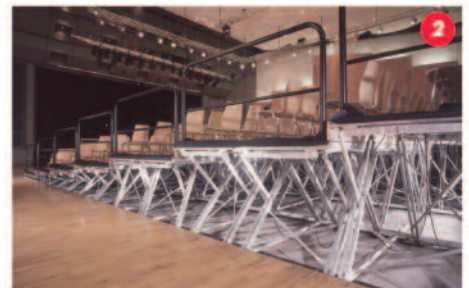
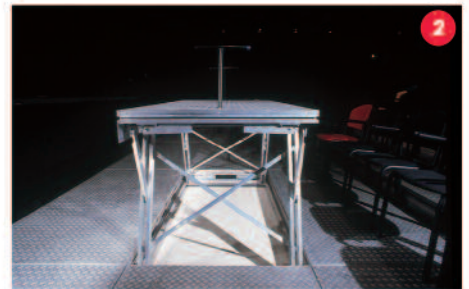
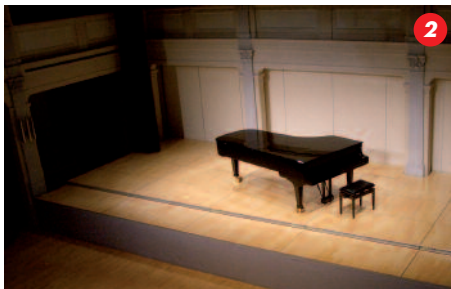
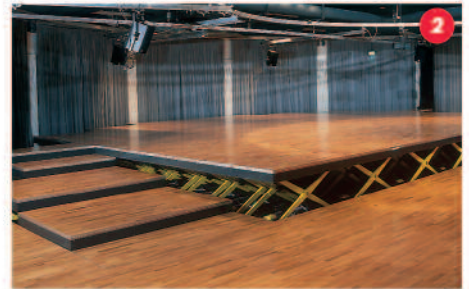
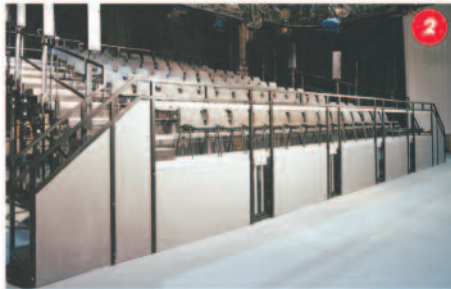



NIVOflex®-Professional

The premium-scissor-type platform



NIVOflex®-Professional – High-tech-design with international awards

- height-adjustable scissor-type construction
- fast set up/dismantling slope possible
- available with all offered surfaces
- floor-protecting with lower-frame for equal distribution
- TÜV-tested and approved with factor 1,7 safety

Product description

A ready-made scissor-type platform made completely of aluminium, able to bear extremely heavy loads as a premium product for the professional presentation area and the presentation of products. All component parts are finished with highest precision and assembled in an easy-to-maintain fashion; all moving parts are fitted with maintenance-free, self-lubricating plastic discs. The heavy-duty upper frame is fitted with an inbuilt multipurpose track for the connection of the platform modules to each other and for the fastening of accessories like cover plates, railings, product descriptions, holders for prospectuses and catalogues, price tags and many more.

Areas of operation

Presentation of events

Presentation of products

NIVOflex®-Professional can be set-up up to 200 cm height by placing the platforms on top of each other. Of course with proved calculation.



Guide carriages with locking device.



Height adjustment by means of Bowden cable system.



All building parts are screw fastened.

Assembling and dismantling

The scissor-type construction is conveniently unlocked by the Bowden cable system. So the desired height can be adjusted up to 1 m, staggered in steps of 20 cm (alternatively as theatre elevation $16\frac{2}{3}$ cm). The catch of the height-adjustment arresting device clicks audibly and visibly into place.

Technical Data

NIVOflex®-Professional

- Dimensions 2 m x 1 m
- Load 750 daN/m²
- Maximum adjustable height 100 cm
- Weight 69 kg
- Storage height 15.5 cm
- Load-bearing surface 25 mm



Technical data
NIVOflex®-Giant

- Dimensions 3 m x 1 m
- Load 750 daN/m²
- Adjustable height 80-150 cm
- Weight 123 kg
- Storage height 15.5 cm
- Load-bearing surface 25 mm

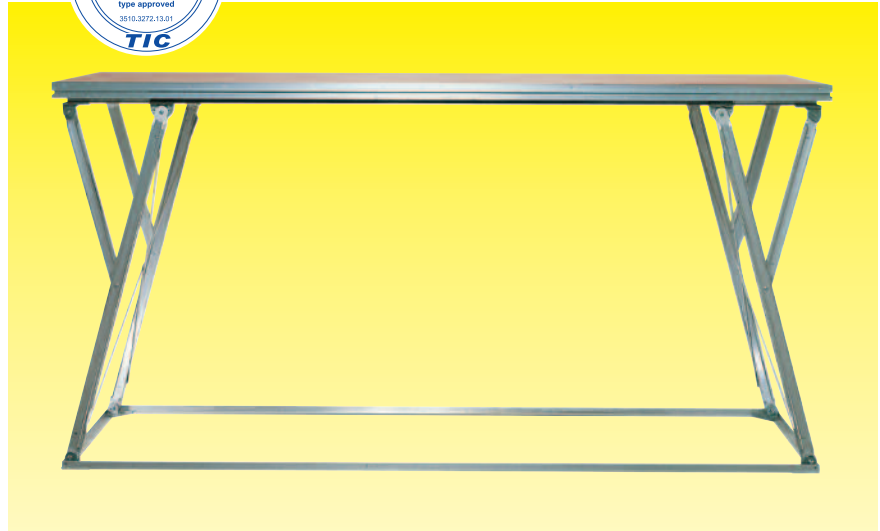

Version NIVOflex®-Giant. Dimensions 3 x 1 m for heights up to 150 cm.

NIVOflex®-Giant



Grandstand with detail of last row.



Grandstand back view.



Technical data
NIVOflex®-Elephant

- Dimensions 2 m x 1 m
- Load 750 daN/m²
- Max. adjustable height 150 cm
- Weight 110 kg
- Storage height 15.5 cm
- Load-bearing surface 25 mm

NIVOflex®-Elefant

NIVOflex®-Elephant for heights up to 150 cm.

NIVOflex®-AirStage

Stationary-platform with "servo"-setting of height

Product description

Aluminium scissor-type platform with "servo"-height setting.

As strength reserve, gas-pressure springs in the scissor-arms support the movement procedure. Thereby AirStage requires significantly less brute force than previous stationary platforms of whatever make. That protects the health of your staff and shortens the rebuilding time.

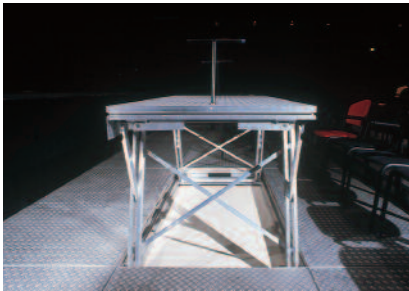

Areas of operation

For fixed installation in multifunctional events in the hall and stage areas. As flexible hall floor adjuster, particularly suited for houses without storage facilities and few staff to make the adjustments.

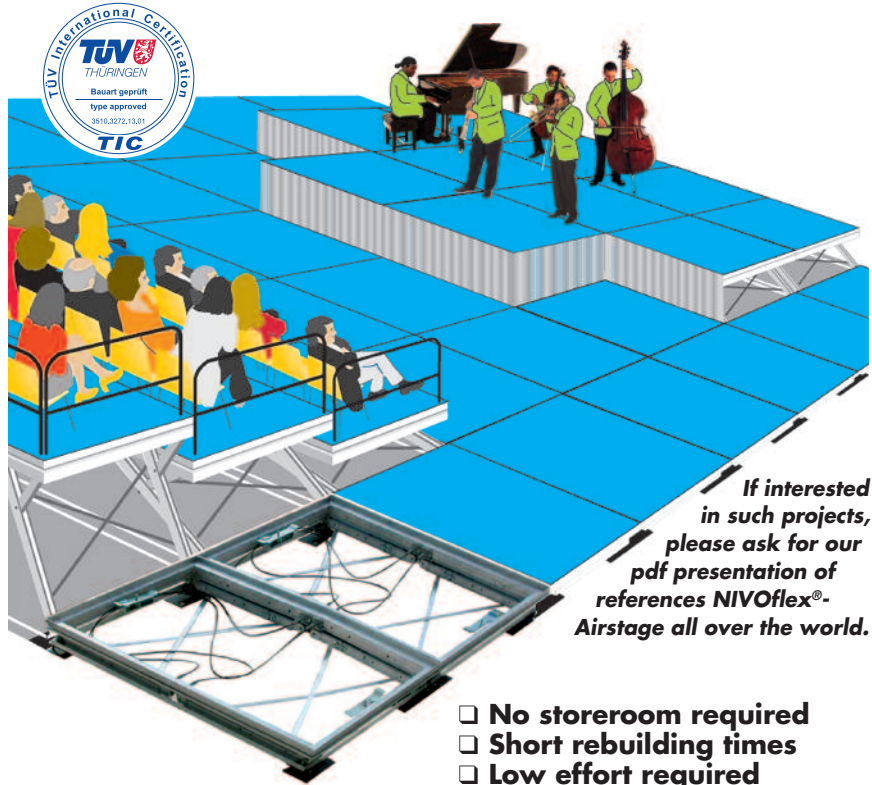

- No storeroom required
- Short rebuilding times
- Low effort required
- TÜV-tested and approved with factor 1,7 safety

Setting heights

The height of the NIVOflex®-AirStage can be set with two insertable handles. The effort per platform is low. The unlocking occurs centrally through a lever. So the desired height can be quickly set in adjustable stages of 20 cm or 16²/₃ cm. The maximum height can reach up to 150 cm according to implementation.



The types NIVOflex®-Comfort and NIVOflex®-AirStage for the fixed installation will be adjusted from above through platform surface.

Installation

With a build-in depth of only 20 cm the NIVOflex®-AirStage platforms are built under floor level und levelled out. In the lowest height setting the surfaces then come into a spacing of 5 mm flush with usual hall floor.

Airstage-refitting

With the Airstage-refitting kit you can also refit Nivoflex®-stationary platform into Airstages. And with very little outlay.

Areas of operation

Presentation of events

NIVOflex®-Stabilo

The largest selling scissor-type platform



NIVOflex®-Stabilo. More than 150,000 platforms are in daily use.

- variable height scissor-type construction
- fast assembly/dismantling - slope possible
- available with various surfaces
- floor-protecting load-distributor - secure stand
- TÜV-tested and approved with factor 1,7 safety



Guide carriages with locking device.



Height adjustment through Bowden cable system.

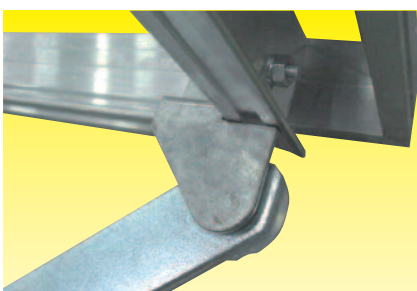

All construction parts are screw fastened.

Technical data NIVOflex®-Stabilo

- Dimensions 2 m x 1 m
- Load 750 daN/m²
- Maximum construction height 100 cm
- Weight 56 kg
- Storage height 20 cm
- Load-bearing surface 22 mm

Product description

A lighter scissor-type platform with aluminium upper frame and a scissor-type system in steel – light construction for the general events area and the presentation of products. Optimal security of stand. The large-volume load-sharing feet provide a low pressure-to-area contact and make the NIVOflex®Stabilo platform system suitable for sensitive floors. The upper frame contains an integrated multifunction track for the binding of the platform elements together and for the fastening of accessories like curtains, banisters, product descriptions, containers for prospectuses and catalogues, price tags and much more. The 22 mm strong load-bearing surface is available in various surfaces.

Assembly and dismantling

The scissor-type construction is conveniently unbolted by the Bowden cable system. Thus the desired height can be quickly set up to 1 m ranging in stages up to 20 cm (on request also in theatre stages of 16²/₃ cm). The catch of the arresting device thereby clicks into it audibly and visibly. The platform allows the setting of a slanting stage.

Areas of operation

Presentation of events

Presentation of products

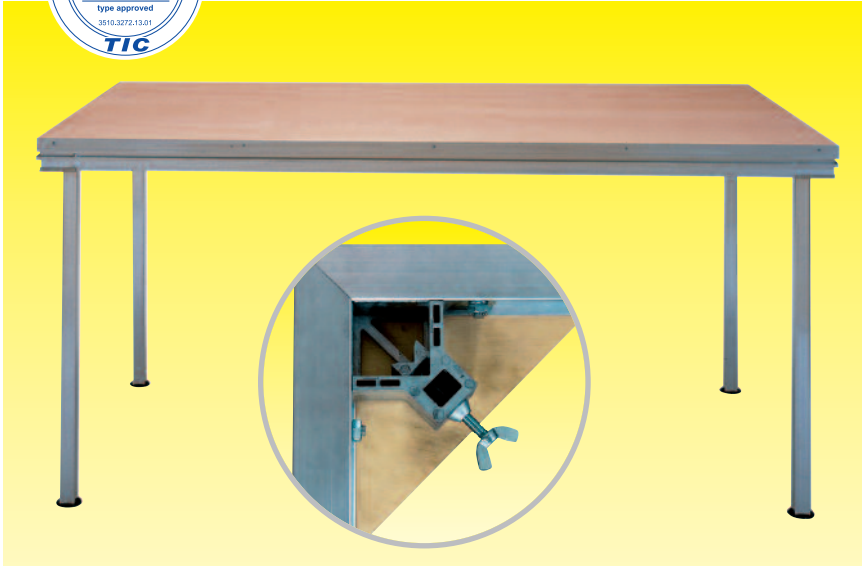

NIVOflex®-Light. Ideal for special heights, special dimensions and special shapes.

- only weighs 29.5 kg
- available with various surfaces
- screw-lock for legs □ 40 mm
- fast lock-in for legs ○ 48.3 mm
- TÜV-tested and approved with factor 1,7 safety

NIVOflex®-Light light, fast, ergonomic

Product description

An extremely light platform with plug-in feet for the general event-staging area, the presentation of products and level-setting with industrial production processes. The encircling multi-function track serves to combine the platform elements and to fasten accessories such as curtains, banisters, product description, containers for prospects and catalogues, price tags and much more. Clamping of the plug-in feet without tools and in a flash. The 22 mm strong load-bearing area is available in various surfaces. The ideal platform system for special dimensions and special shapes.

Areas of operation

Presentation of events

Presentation of products

Industry

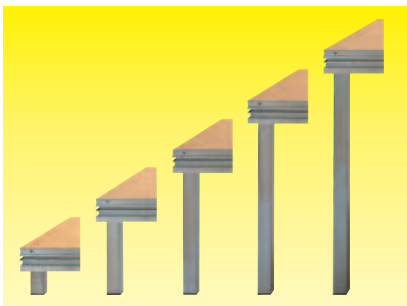

Plug-in 40 mm. Fixed length.

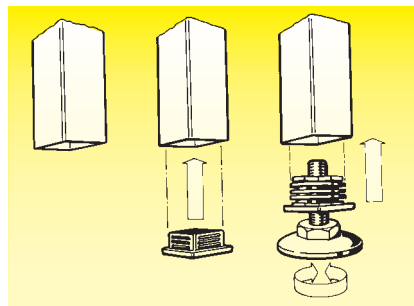

Standard foot. Middle.
Levelling foot. Right.
Optional for the levelling out of small unevenness.

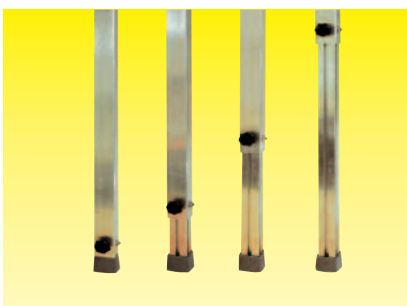

Plug-in 40 mm. Telescopic.

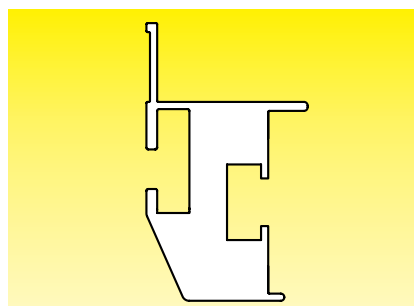

Ergonomic profile for easy handling.

Assembling and dismantling

Quick and easy. Proven clamp-connectors provide a secure connection and simple handling. The plug-in feet can be assembled without additional tools. The optional telescopic feet level uneven ground, e.g. for outdoor use.

Technical data NIVOflex®-Light

- Dimensions 2 m x 1 m
- Load 750 daN/m²
- Maximum adjustable height 80 cm without cross-bracing
- Weight 29.5 kg
- Storage height 8 cm
- Load-bearing surface 22 mm

NIVOflex®-Event Scissors 80/100

The alternative to the Bowden cable



NIVOflex®-event scissors.

- only 44 kg dead weight**
- available with various surfaces**
- unlocking by hand**
- TÜV-tested and approved with factor 1,7 safety**



Setting the height of the scissor-type legs is child's play.

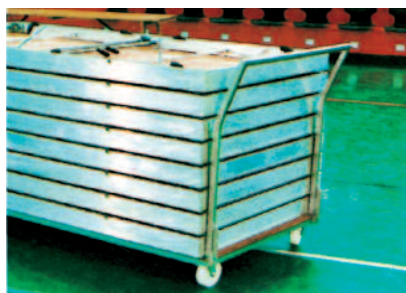

Carrying-trolley for platforms.

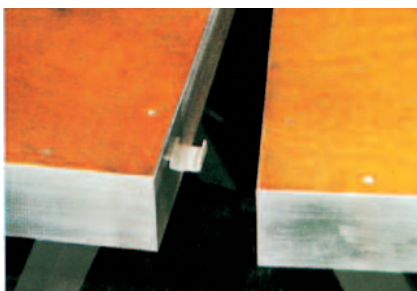

Automatic hooking of the platforms with each other.



Setting of the textile masking with Velcro tapes.

Product description

Next to the weight the height adjustment and/or elevation adjustment as well as the connection of the platforms with each other are decisive. Scissor-type platforms are adjusted with a handgrip and for safety reasons the bolts of the adjustment mechanism click audibly and visibly into the profile of the frame. All profiles are of aluminium. All aluminium shaped parts of a high strength special alloy. The observance of the tolerances as well as the overall production are constantly supervised. Our scissor-type platforms stand absolutely safe, whether linked together or as single platform. All construction parts are screwed together. All moving parts maintenance free.

Assembling and dismantling

On erection, the platforms are automatically hooked and/or linked with each other. However in practice there are always new cases where absolute bracing is needed. A platform linking brace stabilises the surface.

Technical data

NIVOflex®-Event Scissors 80

- Dimensions 2 m x 1 m
- Load 500 daN/m²
- Max. set-up height up to 80 cm
- Weight 44 kg
- Storage height 10 cm
- Carrying surface 22 mm

Technical data

NIVOflex®-Event Scissors 100

- Dimensions 2 m x 1 m
- Load 500 daN/m²
- Max. set-up height up to 100 cm
- Weight 50 kg
- Storage height 17,5 cm
- Carrying surface 22 mm

Areas of operation

Presentation of events

Presentation of products

NIVOflex®-Event

The platform for the professional operation



Product description

An extremely light plug-in foot platform with anodized smooth upper frame for the general event area, product presentation and the level equalization for industrial production flows. The integrated linking hooks serve to stabilize the platforms with each other. The special corner design can be used for attachment of accessories like curtains, banisters and much more. Clamping of the plug-in feet without tools and in a second. The 22 mm strong support plate is available with various surfaces. The ideal platform system for special sizes and special shapes.

NIVOflex®-Event – The optimum system for special sizes, shapes or colours.

- plug-in legs square or circular tube 40-60 mm
- fast erecting and dismantling
- height levelling possible (telescope legs)
- available in various surfaces
- non-slip with large-area rubber feet on request
- construction manual for stages and tribunes up to 4 m high
- TÜV-tested and approved with factor 1,7 safety

Assembling and dismantling

Fast and easy. Approved integrated plastic hooks or clamp-binders provide a safe connection and simple operation. The plug-in feet can be installed without additional tools. The optional telescopic feet level uneven ground.

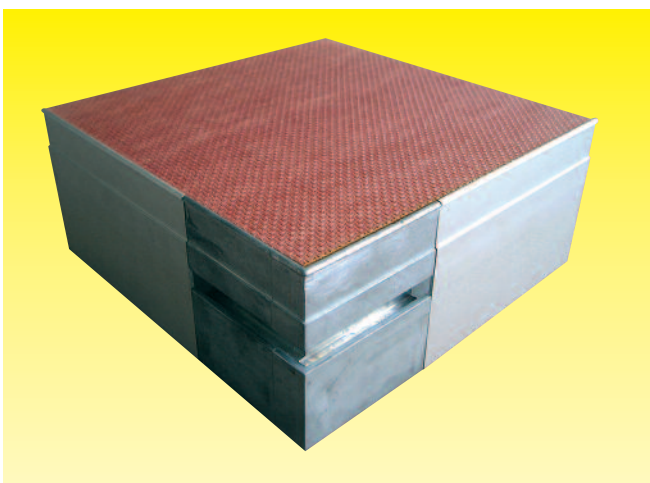

Shock-proof combi-corner for connection with different platform systems.

Technical data

NIVOflex®-Event/Match

- Dimensions 2x1 m
- Special sizes on request
- Load up to 750 daN/m²
- Maximum build-up height 4.00 m (according to the construction manual)
- weight 32/38 kg
- storage height 9 cm
- load-bearing surface 22 mm

Areas of operation

Presentation of events

Presentation of products

Industry



NIVOflex® Event with DIN railings.

Higher dynamic forces are accepted with the use of joining clamps.

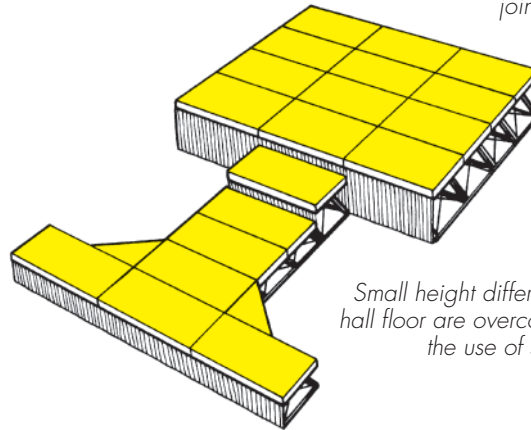
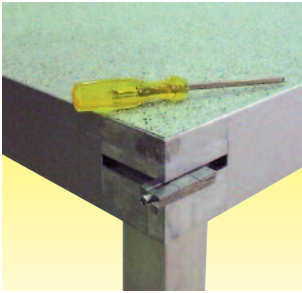
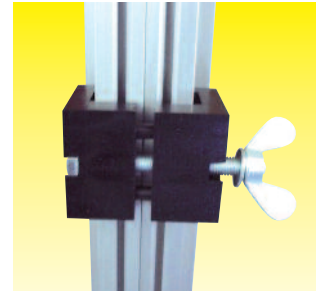

Small height differences in the hall floor are overcome through the use of spindle feet.

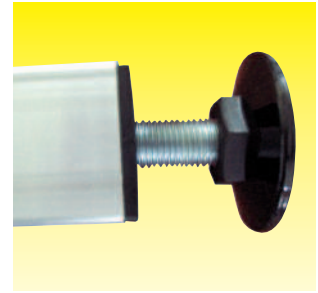

The platform corner guarantees a linking with different platform systems.

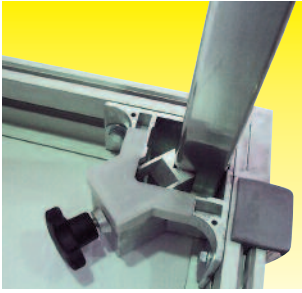

High-quality leg clamps accept leg sets (straight or telescopic legs) from 40 to 60 mm round or square.

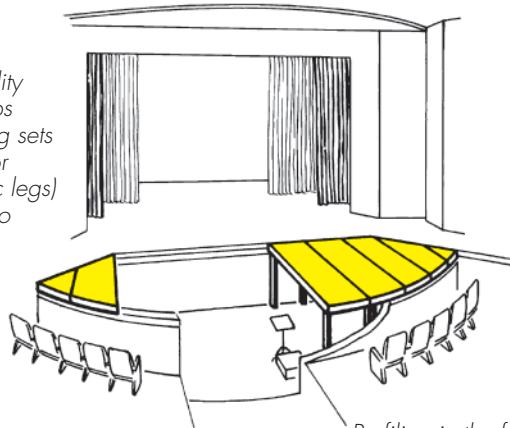
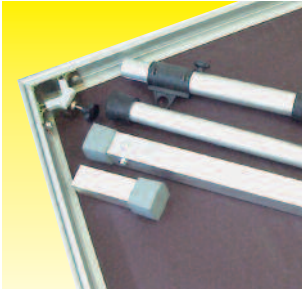

Profiling in the frame enables the attachment of textile or wood facing.



A variety of stair constructions with or without handrails is available.



Leg connectors in round or square form are used for assembly of stepped (rostrum) constructions.

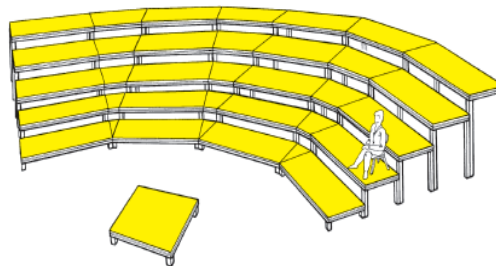

Storage and transport occur with transport trolleys. Even the use of plug-in rollers is possible.





NIVOflex®-Multi

The premium plug-in foot platform

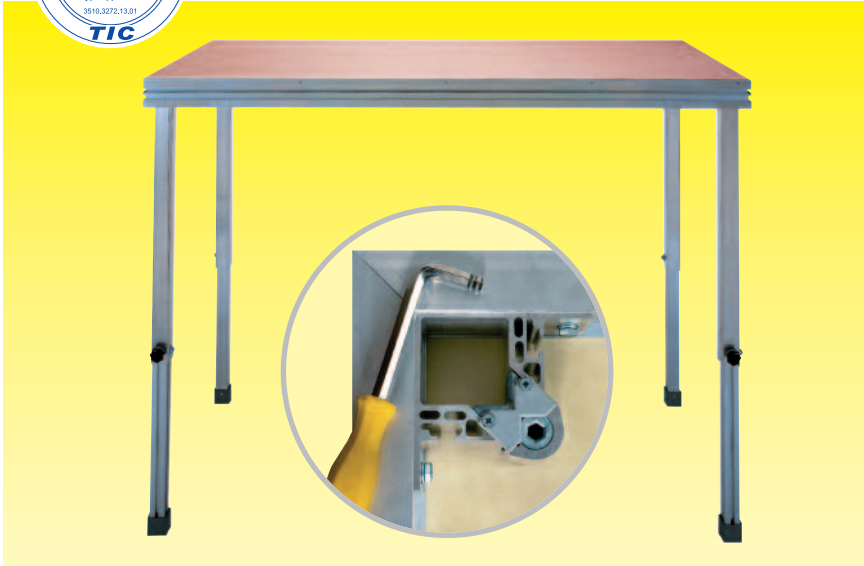

NIVOflex®-Multi. The optimum system for special heights, special sizes and special shapes.

- ❑ for the professional event area
- ❑ up to 200 cm in height without lateral bracing
- ❑ available with all offered surfaces
- ❑ telescopic feet for uneven floors
- ❑ TÜV-tested and approved with factor 1,7 safety

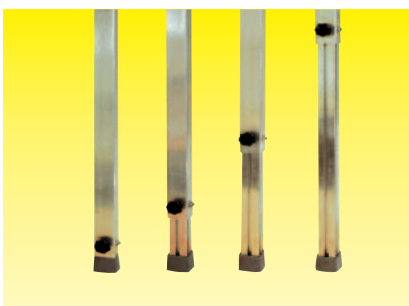

Plug-in feet 60 mm, can be telescoped.

Assembling and dismantling

The plug-in feet can be quite simply plugged into the quick-lock mechanism and retained without applying any force. A small turning of the lever is sufficient. The platform can be quickly and simply joined with the joining clamp.



Plug-in feet 60 mm, fixed length.



Quick-lock mechanism.

Product description

TüV-tested plug-in foot platform for extreme heights and loads at professional events, for the presentation of products and the levelling out of unevenness at industrial production events. With heavy duty aluminium frame and integrated multi-function track. Thereby the Multi-Platforms can be linked together, like all NIVOflex® platforms, by means of clamp binders and accessories like flats, railings, product descriptions, holders for prospectuses and catalogues, price tags and many more. The 25 mm load-bearing area is available with all offered surfaces. Special coatings on request. The optimum system for special heights, special sizes and special shapes.

Areas of operation

With the largest platform heights or with uneven ground surfaces, e.g. in the open air or with varying topographies, e.g. on steps. NIVOflex-Multi is approved for stages and tribune constructions up to 200 cm in height without additional lateral bracing. With such an additional lateral bracing stages and tribune constructions up to 400 cm in height and more are possible.

Areas of operation

Presentation of events

Presentation of products

Industry

Technical data

NIVOflex®-Multi

- Standard dimensions 2 m x 1 m
- Load 750 daN/m²
- Build-up height without lateral bracing up to 200 cm, build-up height with lateral bracing up to 400 cm
- Weight 44 kg
- Storage height 9.8 cm
- Support plate 25 mm

Special platforms

For all NIVOflex® platform systems special heights, sizes and shapes are possible.

This systems permit every possible special shape and thereby offer the optimum conditions to the configurative freedom of stage surfaces and constructions

Here are some examples of made to measure platform shapes:

- square
- trapezoid
- triangle
- semi-circle
- and more

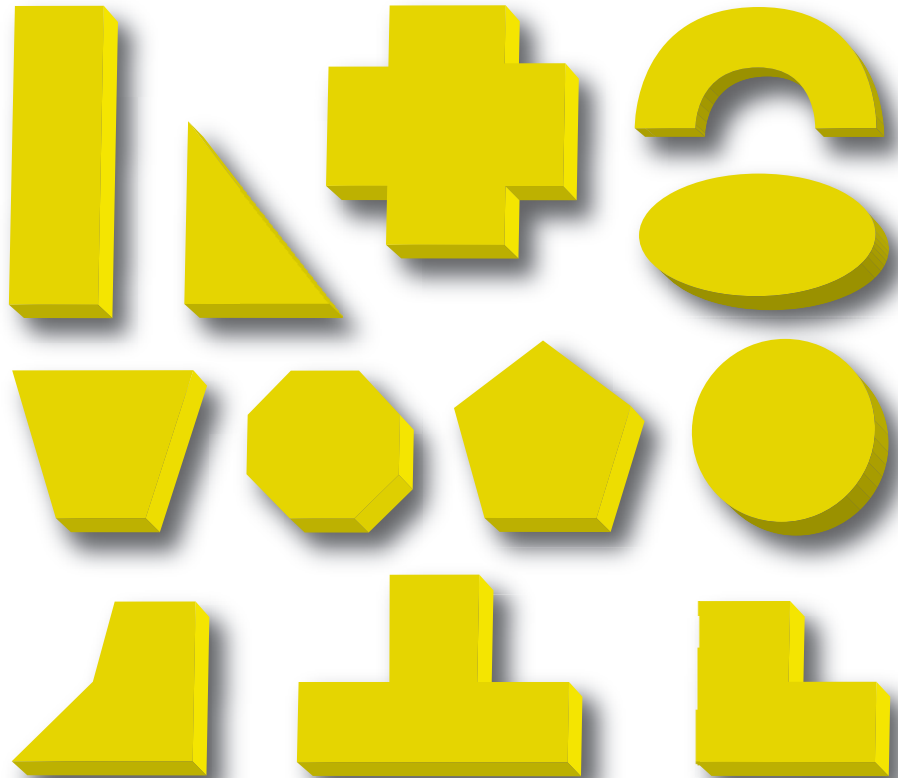

Aluminium checker plate



TIPLA black glazed



Silkscreen top for outdoor use



Parquet/Laminat



TIPLA natural glazed



Beech natural glazed



Different surfaces

Water-resistant glued silkscreen top, checker plate, Linoleum, carpet, parquet, Laminat, Acryl, tiles, or floor tiles etc. are possible on request.

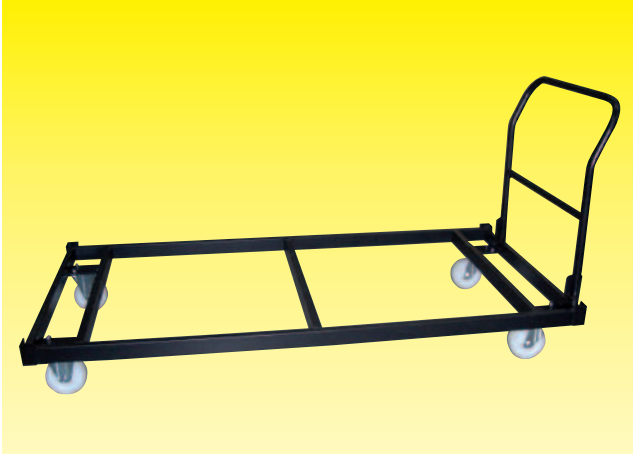

Trolleys for Transport and storage
of NIVOflex® platforms and all kinds of accessories etc.
Casters of PVC or soft plastic for different floors.



Floor shutter/appliance inserts
floor sockets, floor shutters, line feed-troughs, microphone sockets, sockets for music stands.

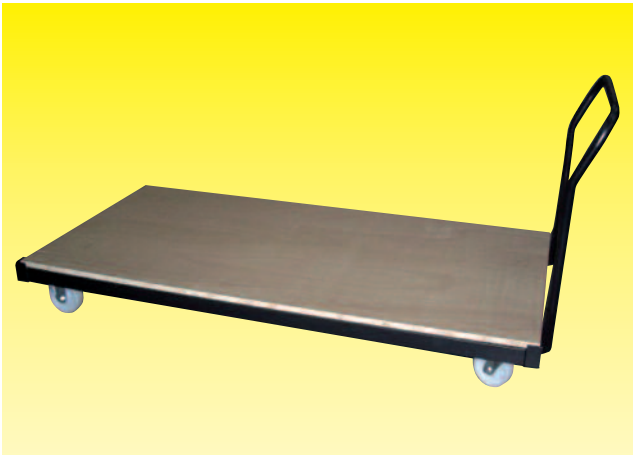

Trolleys for Transport and storage
of NIVOflex® platforms with wooden top. Otherwise same as above.



Trolley set for NIVOflex®-Light or NIVOflex®-Multi, NIVOflex®-Event - consisting of two steering rollers and two fixed rollers made of soft or hard plastic for a variety of floor surfaces. For converting plug-in foot platforms into trolleys. Push bar optional.

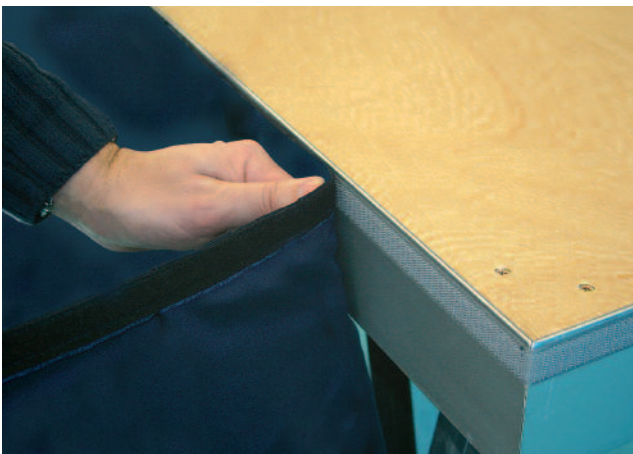

Textile curtain
for a decorative covering of your mobile stage. Barely flammable in accordance with DIN 4102 B 1, standard design smooth without pleats. Standard colours black, brown, red. Special colours on request, easy installation with Velcro strips.

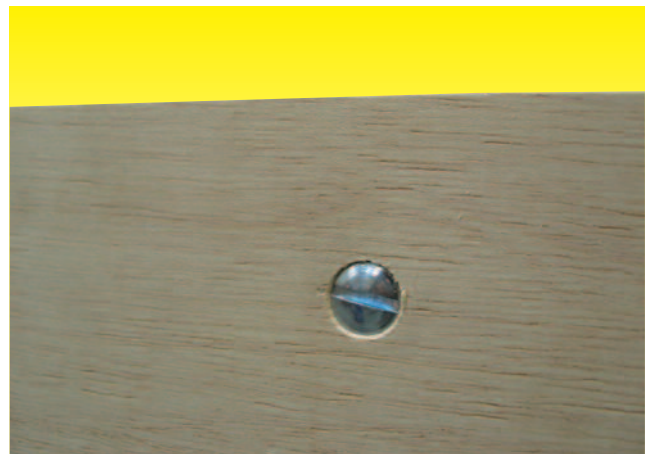

Wood panelling
for a stable panelling of your stage. Connection almost invisible with countersunk screws in the corresponding channel. Sanded down to be painted on-site. Other panels in accordance with your special requirements also available.

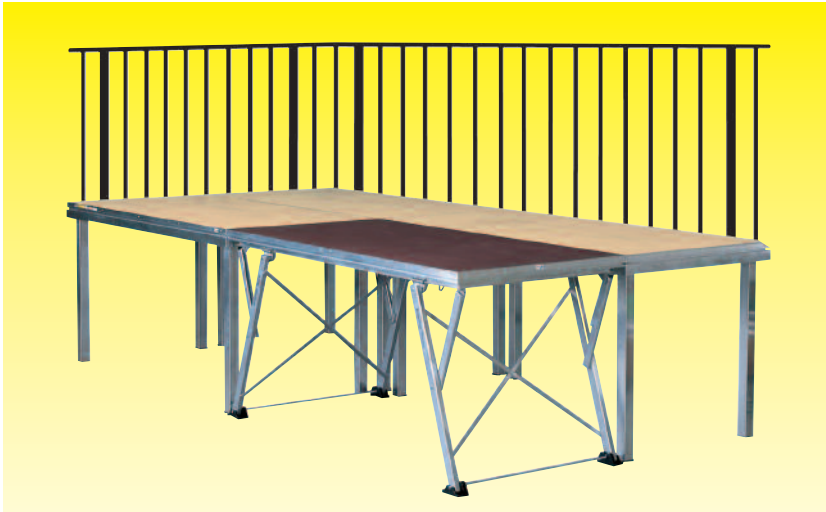

NIVOflex® is perfect with all the particular accessories.

The connection is made easily with the surrounding channel. The necessary parts for the connection are included in our shipment.

Sicherheitsgeländer
DIN 4112, for Professional, Multi and Event.



Protection against falling
Tubular steel, black powder coated, high grade steel, other colours on request.

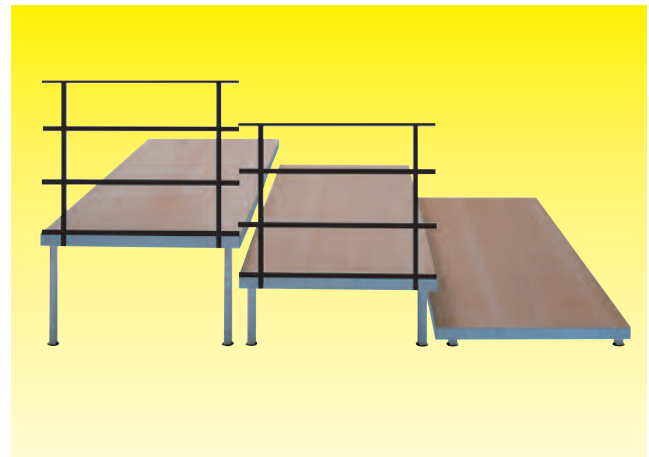

Special protection against falling
for steps and stage surfaces with varied heights made of high grade steel and tubular steel, black powder coated, other colours on request.



Safety railings in accordance with DIN 4112 standard for scissor-type platforms
made of tubular steel, black powder coated, other colours on request.



Variable stair cases
for different stage heights with telescopic railings made of high-grade steel, black powder coated, other colours on request.

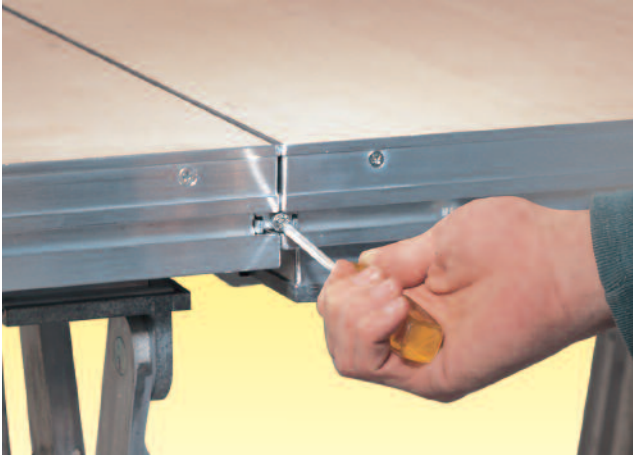

Clamp connectors

Patented! For the rapid and secure connecting of the NIVO-flex[®] platforms with each other.



Sliding nuts

For simple and problem-free attachment of NIVOflex[®] system accessories anywhere along the circumferential multi-function channels.



Connecting profile

For connecting the platforms in series for elevated rostrums and step constructions.

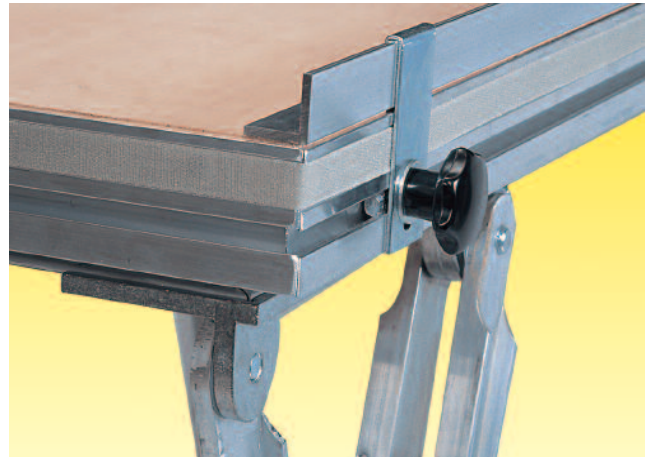

Seating clamp

Prevents seats from sliding.



Leg to leg connectors

Special profiles for connecting the platforms in series for elevated rostrums and step constructions.

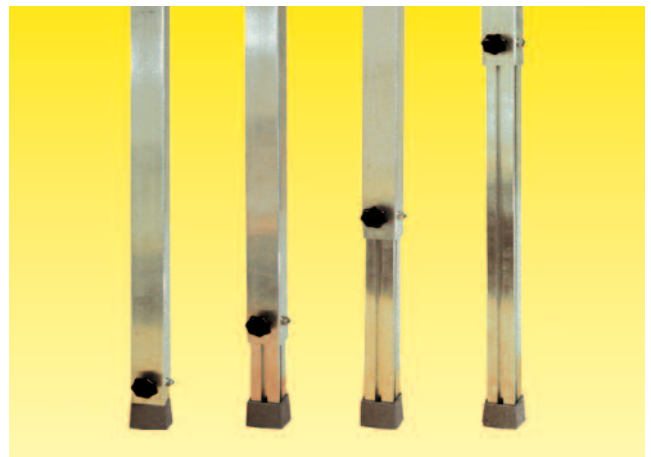

Telescopic legs

for variable adjustment and levelling of floor unevenness. On request with rubber pads.

	Y Scissors				X Scissors		Plug in feet platforms					
	Professional 25	Professional Gigant	Professional Elephant	Professional AirStage	Stabilo	Event Scissor 80	Event Scissor 100	Event	Event Match	Light	Multi	
Standard size in cm	200 x 100	300 x 100	200 x 100	200 x 100	200 x 100	200 x 100	200 x 100	200 x 100	200 x 100	200 x 100	200 x 100	
Special sizes/shapes	✓	✓	✓	✓	✗	✗	✗	✓	✓	✓	✓	
Storage height in cm	15,5	15,5	15,5	15,5	20	10	17,5	9	9	8	9,8	
Adjustable heights	20/40/60/80/100	80/100/120/140/150	80/100/120/140/150	20/40/60/80	20/40/60/80/100	20/40/60/80	40/60/80/100	20-100 fixed and telescopic	20-100 fixed and telescopic	20-80 fixed and telescopic	20-200 fixed and telescopic	
Theater raise possible (16 2/3 cm)	16 2/3 33 1/3 50 66 2/3 83 1/3 100	83 1/3 100 116 2/3 133 1/3 150	83 1/3 100 116 2/3 133 1/3 150	16 2/3 33 1/3 50 66 2/3 83 1/3	✗	✗	33 1/3 50 66 2/3 83 1/3 100	16 2/3 - 100 fixed and telescopic	16 2/3 - 100 fixed and telescopic	16 2/3 - 80 fixed and telescopic	16 2/3 - 200 fixed and telescopic	
Special sizes/shapes	✓	✓	✓	✓	✗	✗	✗	✓	✓	✓	✓	
Height adjustment	inside frame by bowden cable*											
Material	from above by Bowden cable**				inside frame by Bowden cable**		Aluminium/Steel		legs in fixed length and telescopic			
Top surfaces	Aluminium	Aluminium	Aluminium	Aluminium	Aluminium/Steel	Aluminium	Aluminium	Aluminium	Aluminium	Aluminium	Aluminium	
Special Top surfaces	Tipla	Multiplex	Tipla	Tipla	Tipla	Tipla	Tipla	Tipla	Tipla	Tipla	Tipla	
Slope	✓	✓	✓	✓	✓	✓	✓	✓	✓	✓	✓	
Approved load	750 kg/m ² x 1,7 = 1.275 kg 500 kg/m ² x 1,7 = 850 kg											
Certificates	TUV tested											
Floor contact	surrounding lower frame				4 floor pads	8 floor pads	8 floor pads	4 floor pads	4 floor pads	4 floor pads	4 floor pads	4 floor pads
Connection with each other	clamp connector NIVOflex®											
Storage area for 10 platforms	3,1 m ³	4,65 m ³	3,1 m ³	✗	4,0 m ³	1,8 m ³	3,1 m ³	3,1 m ³	3,1 m ³	3,1 m ³	3,1 m ³	
Dead weight in kg	69	123	110	70	56	44	50	32	38	29,5	44	
Safety railings possible	✓	✓	✓	✓	✗	✓	✓	✓	✓	✓	✓	
Standard railings possible	✓	✓	✓	✓	✓	✓	✓	✓	✓	✓	✓	

* it is not necessary to turn the platforms for adjustment

** through the platform surface

We reserve the right for technical improvement



Motorised platforms



Manual platforms



Mobile platforms



Complete temporary stages

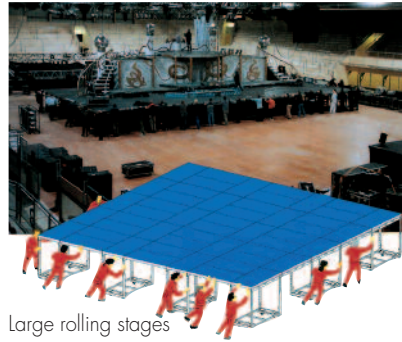

Large rolling stages

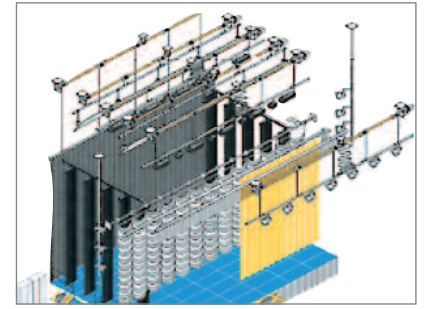

Large rolling stages

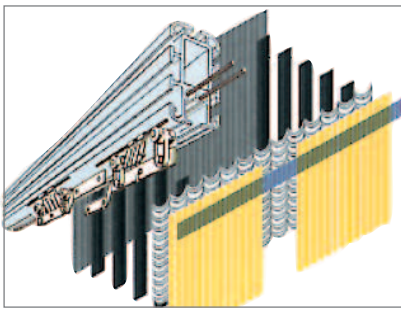

Curtains and tracks

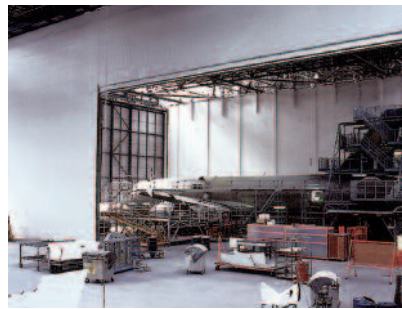

Industrial dividing curtain



Mobile roofs and trussing



Dividing curtains and nets



Telescoping seating



Ball walls



Floor protection, dance floors
Mobile dance floors



Tables and Speakers desk



Turntables